

Name
HIROYUKI MATSUMOTO

Date
2020 / 11 / 22

Truck/City
札幌ショップ 弘明 岐阜店

Event
地元チャレンジ

Front

Shock Position:

FAW222

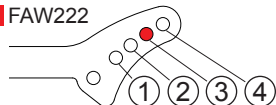

Camber Angle:

- 0 +

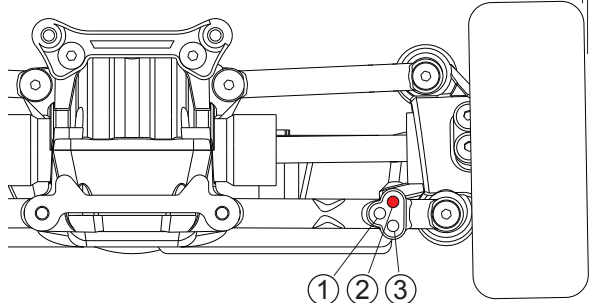

Normal
 FAW205

Type 1
Normal-2.5°

Type 2
Normal-0.5°

Type 3
Normal-1.0°

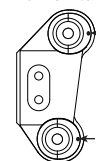
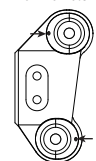
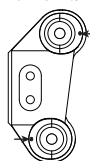

Upper Arm Spacer

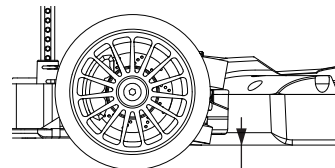
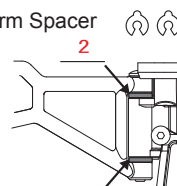

Ride Height:
6.0 mm

Tie Rod:

Normal
 Adjustable

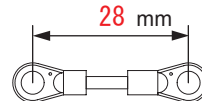

FAW208
Sway Bar: S M H



Front Diff.:

Spool
 Oneway
 Diff.
 4 Bevel
Diff. Oil
グリス

Rear

Shock Position:

FAW223

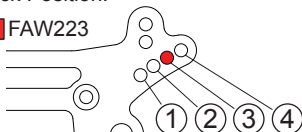

Camber Angle:

- 0 +

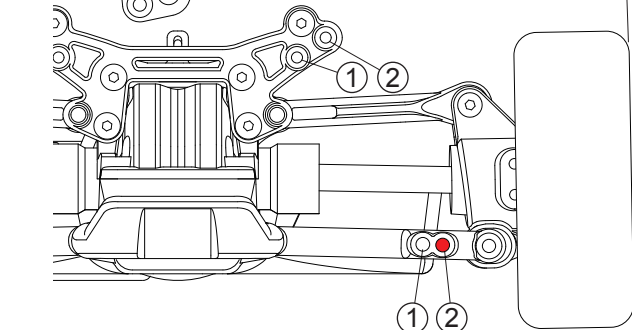

Normal
 FAW206

Upper Arm Position:

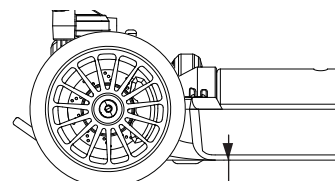
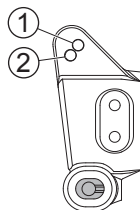

Ride Height:
6.0 mm

FAW208
Sway Bar: S M H



Rear Diff.:

4 Bevel
Diff. Oil
グリス

Shock

Front

Rear

Standard

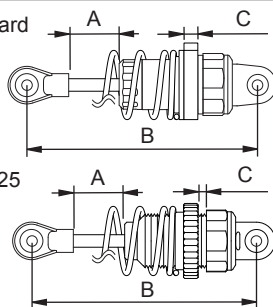

Shock Piston



Shock Oil

500

500

Shock Spring

W (BL) Y R

W (BL) Y R

Shock Length A

mm

Shock Length B

55 mm

Spring Spacer C

2.0 mm

Chassis Width

190mm
 200mm

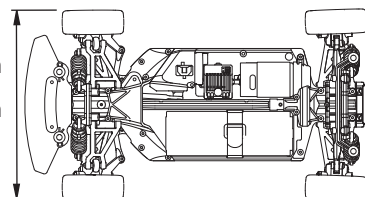

Tire

Tire **KCスリックタイヤ S**

Inner Sponge **KYOSHO Sインナー**

Wheel **15本スポーク白**

Traction Compound 1st: **Mighty イロ-** 2nd:

Comments

Others

Motor **Le Mans 240S 15.5T** (Timing: **Max**)

Pinion/Spur **35T / 68T** Input/Ring **13T / 40T**

Battery **Gensacel Lipo4000** ESC **Le Mans 240S**

Body **NSX** Wing **Normal / +** °

Truck Condition

Smooth
 Bumpy
 Low Truction
 Med. Truction
 High Truction
 Asphalt
 Concrete
 Carpet
 Indoor
 Outdoor

Comments :

: 34461 EP FAZER Mk2シャシーキット使用

: ダンパーオーリング ORG03X使用 : 前後カーボンダンパーステー (FAW222, FAW223) 使用

: T Cアルミダンパーセット FAW225使用 : T Cスプリングセット FAW224使用